

SPECIFICATIONS MYCENTER[®] 3020G

Table	
Table Size	500 x 860mm (19.7" x 33.9")
T-Slot (Width x Quantity)	18mm (0.7") x 5
Maximum Table Load	500kg (1,100 Lbs.)
Travel	
X-Axis Travel	762mm (30.0")
Y-Axis Travel	510mm (20.1")
Z-Axis Travel	510mm (20.1")
Distance from Table Top to Spindle Nose	100 to 610mm (3.9" to 24.0")
Distance from Table Center to Column Slideway	285 to 795mm (11.2" to 31.3")
Spindle	
Spindle Taper	#40 NST
Spindle Speed	40 to 15,000min ⁻¹ 20 to 20,000min ⁻¹
Drive Method	Direct Drive 4-Step Gear Drive
Spindle Motor	22kw (30 HP) AC/5 Min. 15kw (20 HP) AC/10 Min. 15kw (20 HP) AC/15 Min. 11kw (15 HP) AC/30 Min. 7.5kw (10 HP) AC/Cont.
Spindle Torque	95.5 N•m (70.4 ft.lbs) / 15 Min. 133.2 N•m (98.2 ft.lbs) / 30 Min.
Feed	
Rapid Feed X & Y Axes	50 m/min (1,969ipm)
Rapid Feed Z	36 m/min (1,417ipm)
Cutting Feed Rate X, Y	36 m/min (1,417ipm)
ATC	
Tool Storage Capacity	30 Tools
Tool Selection Method	Memory Random
Tool Holder Style	CT 40
Max. Tool Diameter	Ø75mm (Ø3.0") / Ø150mm (Ø5.9") Adjacent Pots Empty
Max. Tool Length	300mm (11.8")
Max. Tool Weight	8kg (17.6 Lbs.)
Tool to Tool	2.2 Seconds
Chip to Chip	4.4 Seconds, Minimum
Utilities	
Power Requirement	30 KVA 200v AC, 3 Phase
Air Requirement	0.5MPa, 300L/min (90 psi, 11 cfm)
Machine Dimensions	
Required Space (W x D)	2,875 x 3,275mm (113.2" x 129.0")
Machine Height	2,925.4mm (115.2")
Machine Net Weight	6,250 kg (13,750 lbs)
Control	
	Arumatik[®]Mi

All specifications subject to change without notice.

Arumatik[®]Mi CONTROL SPECS

3-Axes Controllable
19" Color LCD
Fine Accel/Decel after Interpolation
Linear Interpolation (G01)
Circular/Helical/Spline Interpolation (G02, G03)
Conical Interpolation (G02.1, G03.1)
3-D Circular Interpolation (G02.4, G03.4)
Circular Cutting (G12, G13)
Dwell (G04)
Scaling (G50, G51)
Extended Workpiece Coordinate System (96 Sets)
Single Direction Positioning (G60)
Coordinate System Rotation (G68, G69)
Rigid Tapping
Deep-Hole Tapping Cycle
Pecking Tapping Cycle
Small-Diameter Deep-Hold Drilling Cycle
3-D Tool Compensation (G40, G41, G42)
High Speed, High Accuracy Control
NURBS Interpolation
High-Precision SSS Control (up to 8,192 Block Look-Ahead)
67-Million Pulse Encoder Feedback System
Background Editing
Corner Chamfering / Corner Rounding
Custom Macro B
Custom Macro Common Variables, 700Pcs
8GB Data Server
DNC 1 Interface
Ethernet Interface
Extended Editing (Copy, Move, Change, Merge)
Registerable Programs, 1,000 Sets
1280M Memory
Geometric Command
Inverse Time Feed
Operation Screen Display
Optional Block Skip
Playback Function
Program Restart
RS232C Interface
Tangential Speed Constant Control
Tool Life Management, 400 Sets
Tool Offset Memory C
Tool Offset Pairs, 200 Pairs
Tool Retract and Return
USB Memory Interface
Backlash Compensation

FLOOR PLANS MYCENTER[®] 3020G

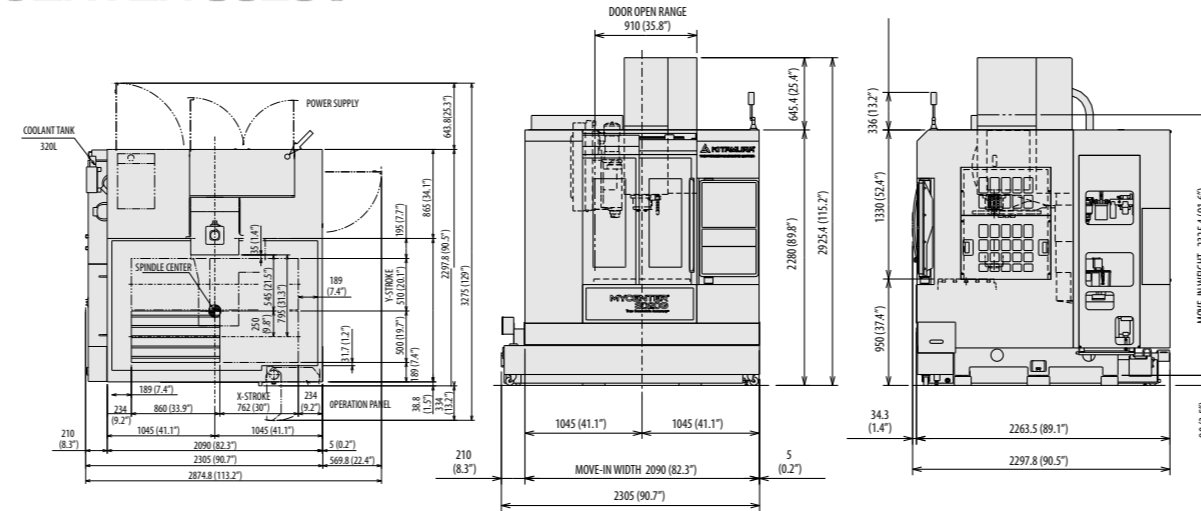

MYCENTER[®] 3020G Sparkchanger

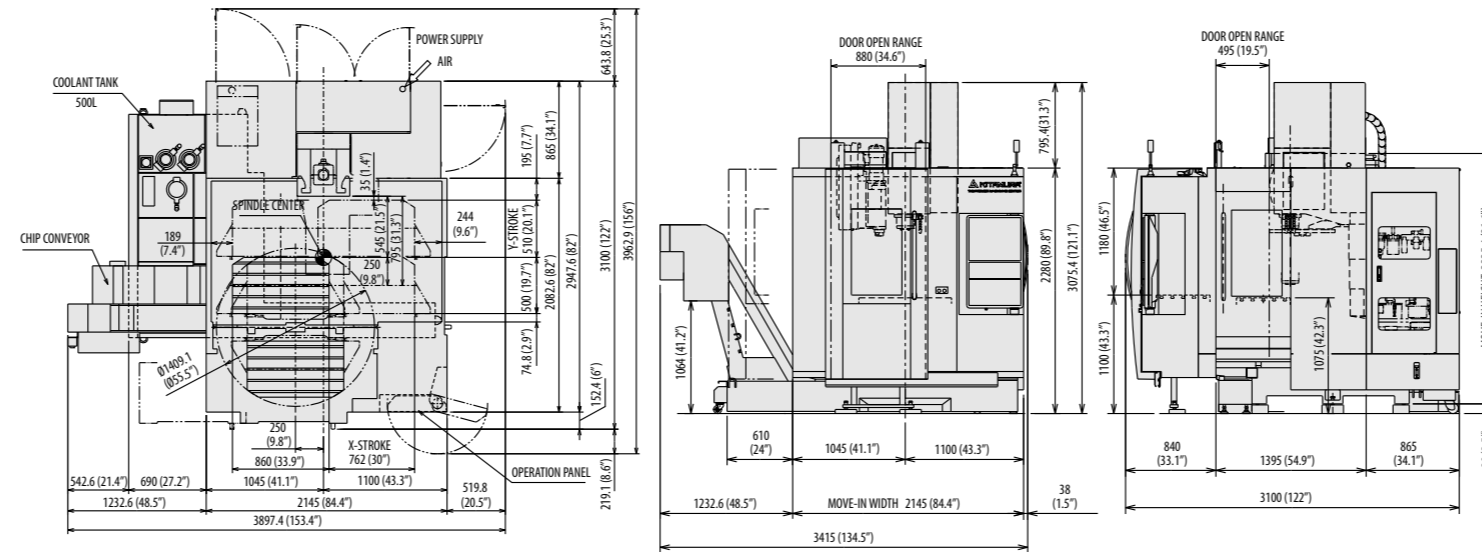

KITAMURA[®] Machining Challenges-Simplified[®]

Kitamura Machinery of U.S.A., Inc.
78 East Century Drive, Wheeling, Illinois 60090
+1 847 520 7755
kitamura-machinery.com
info@kitamura-machinery.com

Kitamura Machinery Co., Ltd.
1870-Toide, Takaoka-City, Toyama Pref., Japan
+81 766 63 1100
kitamura-machinery.co.jp
mycenter@kitamura-machinery.co.jp

Kitamura Machinery GmbH (Europe)
Wahlerstrasse 39, 40472 Dusseldorf, Germany
+49 211 65 6077
kitamura-machinery.eu
sales@kitamura-machinery.eu

PRINTED IN USA 06/19

KITAMURA[®]
Machining Challenges-Simplified[®]

MYCENTER[®] 3020G

HIGH PRECISION VERTICAL MACHINING CENTER



MYCENTER®3020G designed to produce parts with optimum efficiency and precision

Simplify the Complex

World-class Japanese design and construction throughout; space-saving design; ease of use and operator convenience . . . the Mycenter®-3020G has it all.

Rock-solid Meehanite cast construction and premium grade components throughout make this machining center an investment that will pay dividends for years to come.

Powerful Arumatik®-Mi control capabilities and highly rigid, high-speed spindles makes for a machine that easily handles a wide variety of cutting materials and conditions, as well as sophisticated mold/die applications.

Features that make the Mycenter®-3020G the preferred choice

- Solid Induction Hardened Box Ways (X,Y-Axes) produced at our factory. Heavy-Duty Cross Roller Linear Ways (Z-Axis).
- Rigidity and speed to easily cut a wide variety of materials. Ideal for die/mold, aerospace, automotive, general machining and more.
- Fastest rapids in its class - (X & Y: 50 m/min, 1,969ipm) (Z: 36m/min, 1,417ipm)
- State-of-the-art Arumatik®-Mi control transforms your machining flexibility, delivering super accurate parts and ultra-smooth finishes. Easily navigate between features with the latest in customizable, intuitive touch screen technology. Improved cycle times with faster program processing.

Ideal for Small to Medium Size Part Machining

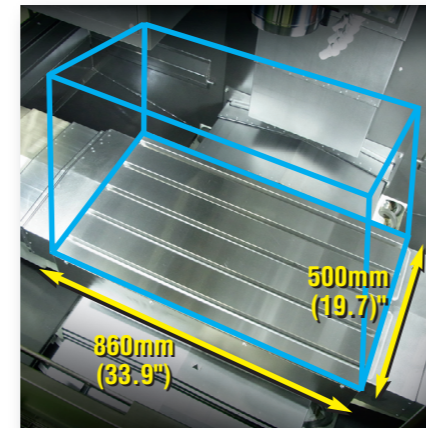

The Mycenter®-3020G is the ideal machine for small to medium size workpieces. Its spacious work envelope and 500mm (19.7") x 860mm (33.9") table provide the flexibility to machine single or multiple fixtured components. There is ample space to easily expand machining capability with the addition of rotary tables to handle more complex 4 and 5-axis work. Add the powerful Arumatik®-Mi Control capabilities and highly rigid high-speed spindle and you truly have a machine that can handle a variety of cutting materials and conditions, as well as more sophisticated die/mold applications.

The Mycenter®-3020G features a high-efficiency chip management system with chip augers on both sides of the bed casting along with standard base wash coolant for a chip free machining environment that boosts productivity and machining accuracy.

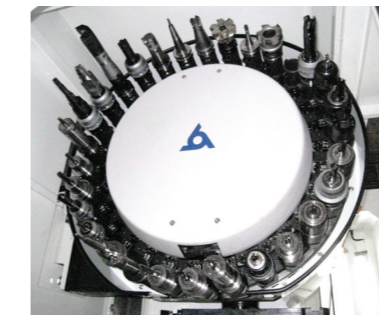

Tool Handling Efficient tool handling slashes idle time to maximize machining profit. The Mycenter-3020G ATC uses a memory-random tool selection system for smooth idle-free tool changes. Its generous 30 tool ATC enhances machining capability.

Unrivaled Precision, Performance & Accuracy

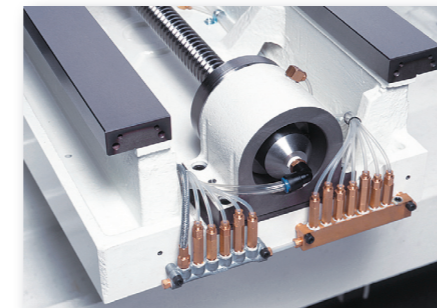

Ball screw temperature is precisely controlled by an internal ball screw cooling system. This eliminates thermal growth and promotes rigidity assuring peak machining precision even under prolonged heavy cutting conditions.

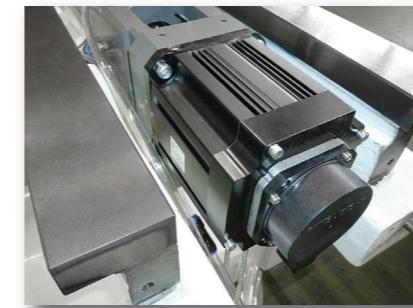

16mm fine pitch ballscrews in combination with 67 million pulse encoder technology provide a new degree of contouring accuracy - at least 4x smoother surface finishes are achieved as a result of this technology.

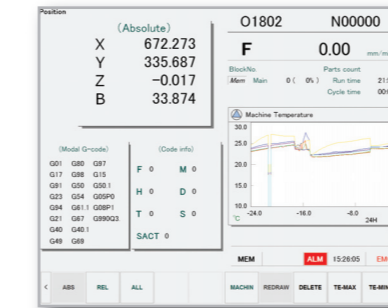

Our high efficiency **Intelligent Advanced Control System (IAC)** consists of a series of strategically located sensors and machine efficiency monitors that work to keep component growth due to machining heat build-up to less than ±5 microns (±0.0002").

Power and Speed that Endures

The **Mycenter®-3020G Series Machining Centers** offer versatility in the choice of spindle configurations available. They are equipped with a standard high speed 15,000min⁻¹, direct drive spindle offering outstanding super-fine finish capability, eliminating the hand-polishing of work pieces making it ideal for high-speed cutting of lighter materials.

Specify the available 20,000min⁻¹ 4-step gear driven spindle to get the robust power necessary for heavy duty cutting of molds and more exotic metals.

Both configurations feature a dual contact design providing simultaneous taper and flange contact for optimum rigidity, reduced vibration and extended cutting tool life.

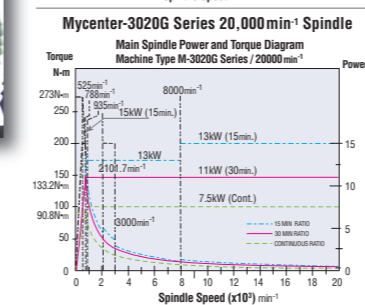
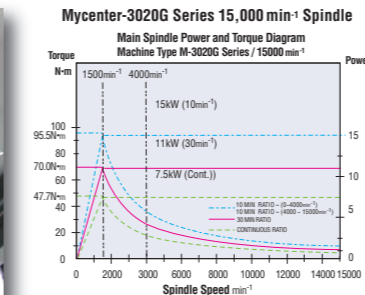
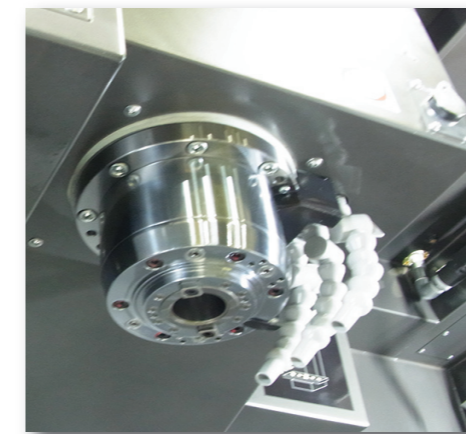

The Perfect Blend of Technology and Hands-On Craftsmanship

Kitamura certified technicians hand-scrape all mounted surfaces requiring assembly. This assures full surface contact and precise alignment that far surpasses the fit and finish of conventional machined mounting surfaces. This labor-intensive process guarantees long-term peak performance and the highest level of accuracy. Kitamura never uses geometry compensation in manufacture to adjust for squareness, parallelism or perpendicularity.

Hand-scraped surfaces assure absolute TGA (True Geometric Accuracy).



Positioning Accuracy: ±0.002mm (±0.000079") / Full Stroke Repeatability: ±0.001mm (±0.000039")

Productivity Enhancing Features



Arumatik®-Mi

Kitamura's original **Arumatik®-Mi Control** is as powerful as it is user friendly. By utilizing unique features such as visual work setting screens, maintenance support functions and video guidance on the 19" LCD, it has been designed to maximize operator potential and performance. The latest in advanced, ultra-intuitive touch screen technology puts a whole new level of control and customization within easy reach.

The Ultra High Speed, High Precision SSS (Super Smooth Surface) Control function improves high speed cutting and optimizes acceleration/deceleration times for each axis. This allows for shorter cutting times with a high degree of accuracy.

acceleration/deceleration times for each axis. This allows for shorter cutting times with a high degree of accuracy.

- Up to 8192 block look ahead
- Up to 270m/min feed with 1mm/block, 4,500 blocks/sec
- Exceptional surface finish capabilities
- Ideal for die-mold/3D applications
- Smoother and faster machining

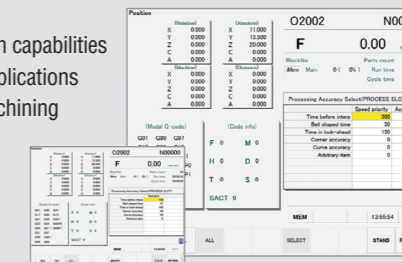

Anywhere RemoTe Email Status Updates

Automatically receive live machine production data anywhere, any time to desktop, smartphone and mobile devices – all based on customizable, pre-set variables. **Anywhere RemoTe TV** offers visual flexibility in monitoring the status of up to 6 machines on one computer screen. Additional machine monitoring suites are available ranging from plus and play to more customized based on application. MTConnet ready adaptor is also an available option for easy communication integration with existing monitoring systems.

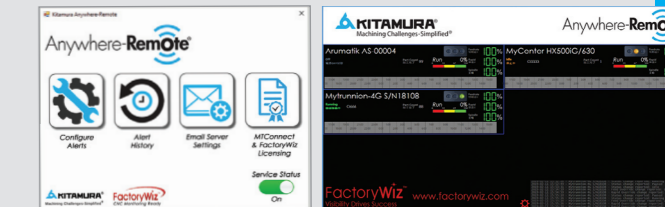

Renishaw Set and Inspect

Integration with Renishaw's Set and Inspect guides users through the process of creating a probing cycle, automatically generating the required machine code for the probing cycle and loads it to the control.

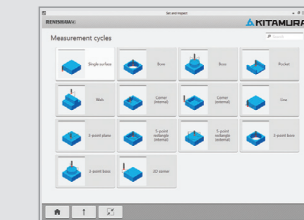

Mycenter®-3020G Sparkchanger with High-Speed 180 degree Rotating Pallet Change System

When maximum production is paramount, the Mycenter®-3020G Sparkchanger delivers. The combination of its high-speed 180 degree rotating pallet changer, lightning-quick tool changer and generous tool capacity meets the most demanding high production requirements.

Operators can safely load work while high-speed machining is in progress for optimum spindle utilization.

In addition, the Mycenter®-3020G Sparkchanger is configured to "cleanly" accommodate the "in-the-field" addition of 4th or 5th-axis rotary tables with no obstructive wiring or cabling. Both pallets can be outfitted with their own rotary tables.

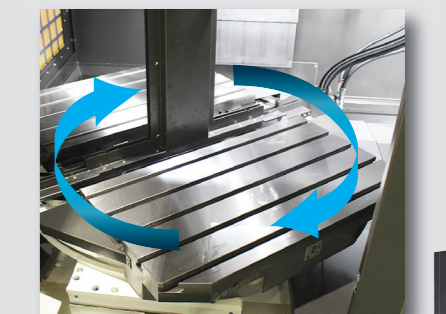

Specifications for Palletized Model

Maximum Table Load	200kg (440 Lbs.)
Distance from Table Top to Spindle Nose	125 to 635mm (4.9" to 25.0")
Required Space (W x D)	3,415 x 3,100mm (134.5' x 122.0")
Machine Height	3,075.4mm (121.1")
Machine Net Weight	7,980 kg (17,556 lbs)