

BF-V13

HIGH PRECISION MACHINERY MANUFACTURER



QUALITY COMES FROM CONFIGURATION, SERVICE COMES FROM HEART

HONGKONG BAOFENG PRECISION MACHINERY CO.,LTD.
DONGGUAN BAOKE PRECISION MACHINERY CO.,LTD.
HUBEI BAOKE INTELLIGENT EQUIPMENT CO.,LTD.

☎ 0769-85633926
0769-82787859

✉ info@baofengmachine.com

🌐 <http://www.baofengmachine.com/>

📍 Hongkong: Room B1, 2/F, Mei Hing Industrial Building, 16-18 Hing Yip Street, Kwun Tong, Kowloon, Hong Kong.

📍 Production base 1: No.63, XinMaLian Xintai road, Dalang Town, DongGuan, China.

📍 Production base 2: No.8, CaiBian South Second street, Dalang Town, DongGuan, China.

📍 Production base 3: East Optics Valley High-end Tool and Mold Industrial Zone, Optics Valley Avenue No.1, Tieshan District, Huangshi, Hubei, China.

DONGGUAN BAOKE PRECISION MACHINERY CO.,LTD.

Feed & Travels

36/30 **1300/750/700**
X/Y/Z (m/min) X/Y/Z (mm)

Linear guideway width X/Y/Z(mm)

45/45/45



24
Tools

ATC adopt unclamp-clamp in advance technology
Tool change time 1.75S (T-T)



3 sliders

Spindle nose to table

130-830mm

Max load on table

1000KG

Y axis 4 guideway

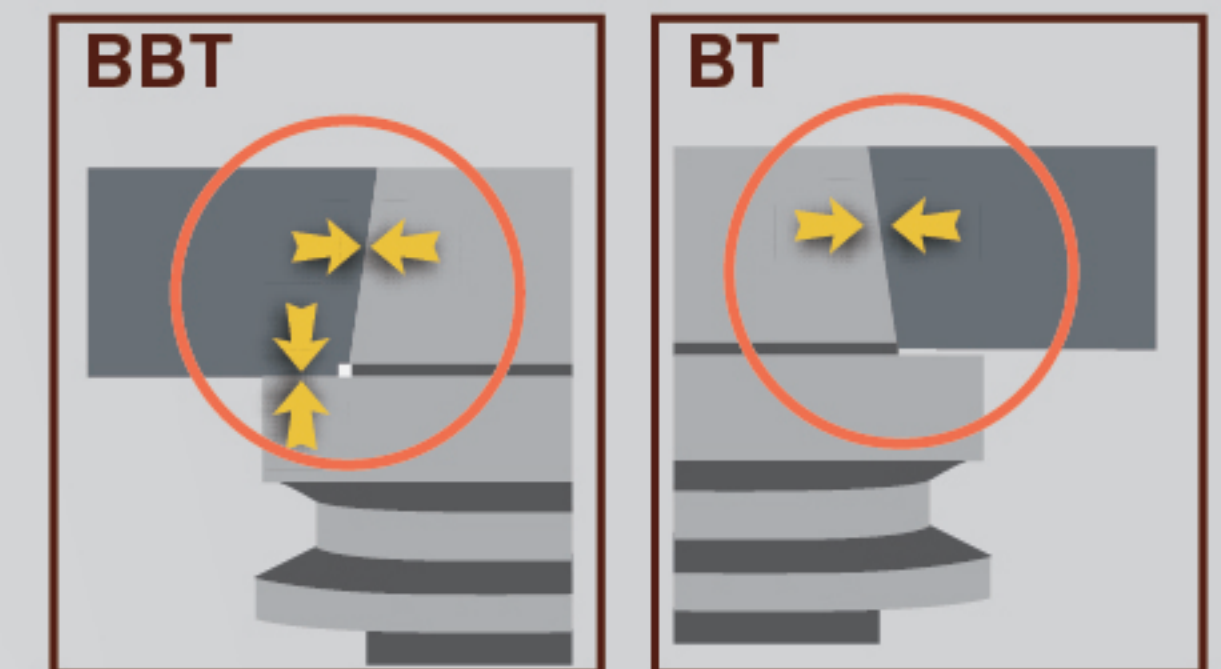
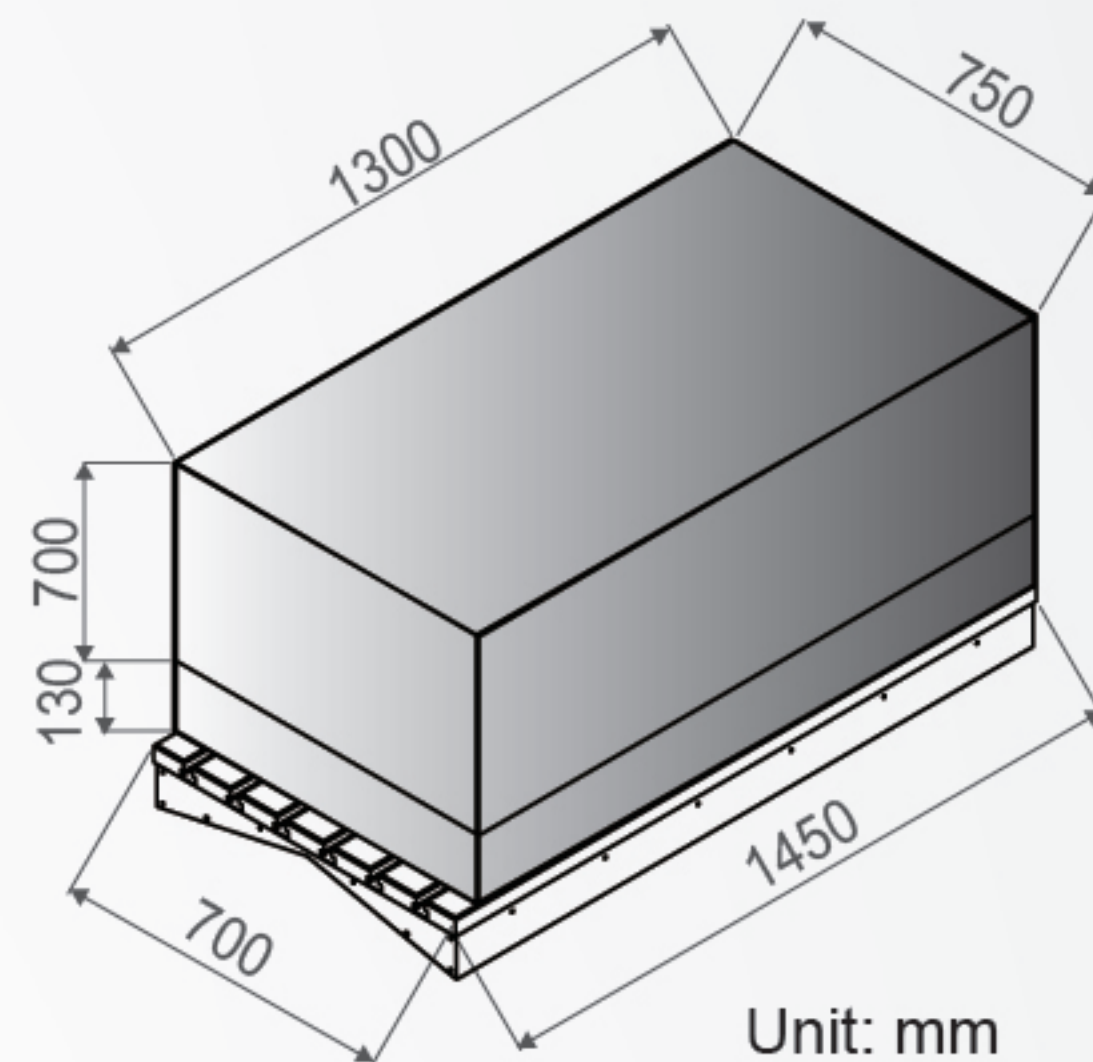

BAOFENG Big Plus spindle

HT300

High strength resin sand type gray cast iron

Fanuc

Spindle BBT40 12000rpm
15KW/95.5NM(S2-15min S3/S6-25%)
 β il 12/12000-B β iIT 12/12000-B(CTS)-Optional

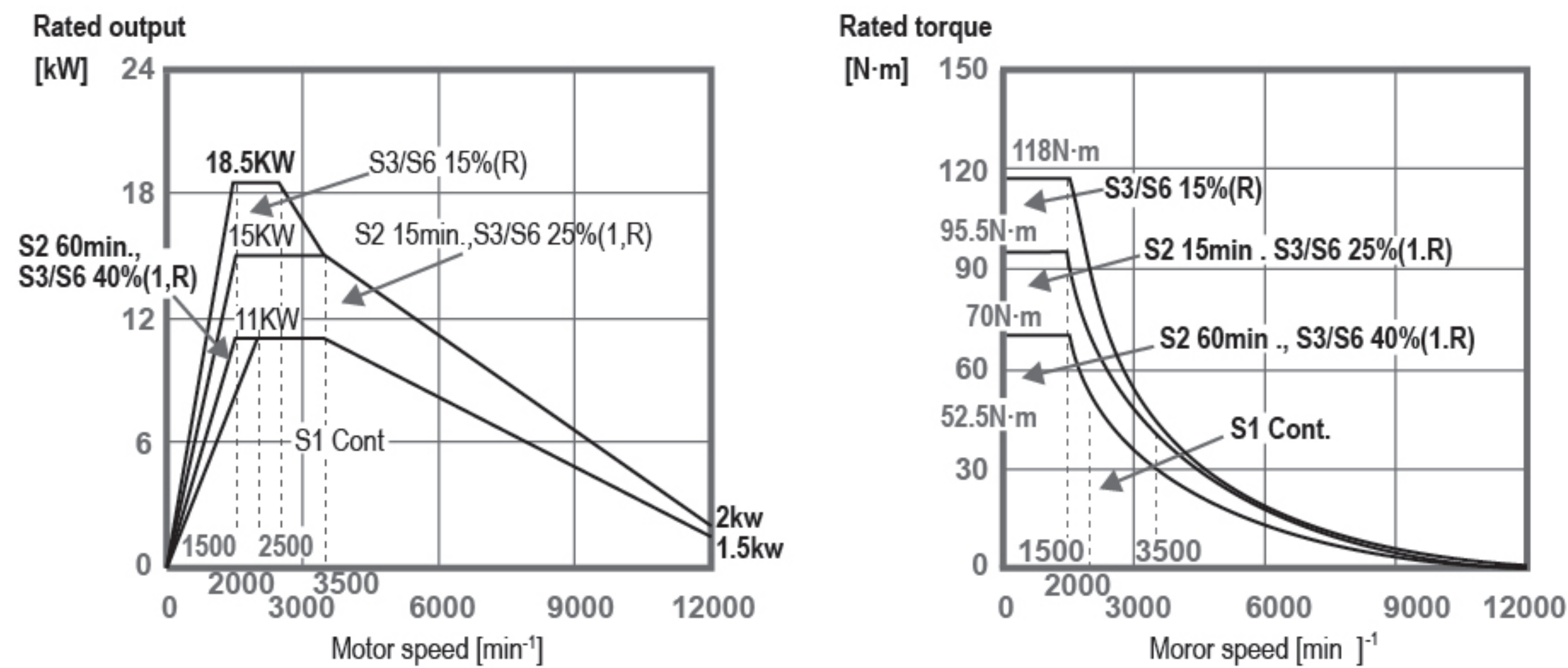

Spindle BBT40 12000rpm
LOW SPEED/18.5KW/118NM(S2 30min,S3/S6-25%)
HIGH SPEED/25KW/59.7NM(S2 30min,S3/S6-25%)
 α il 15/12000-B α iIT 15/12000-B(CTS)-Optional

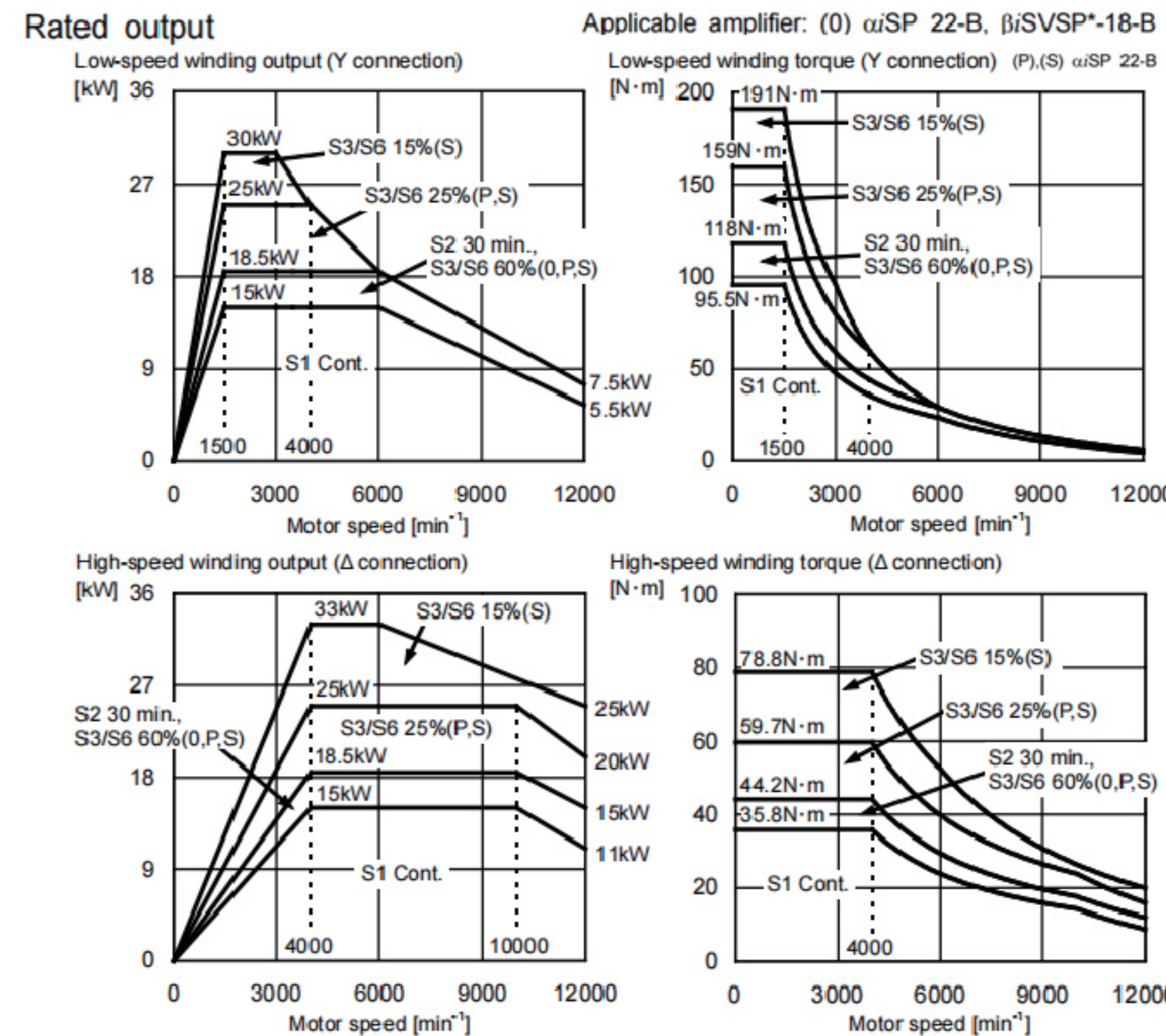

Mitsubishi

Spindle BBT40 12000rpm
15KW/95.5NM(S2-15min S3-25%)
 SJ-DG11/120-14T
 SJ-DG11/120-14T-S(CTS)-Optional

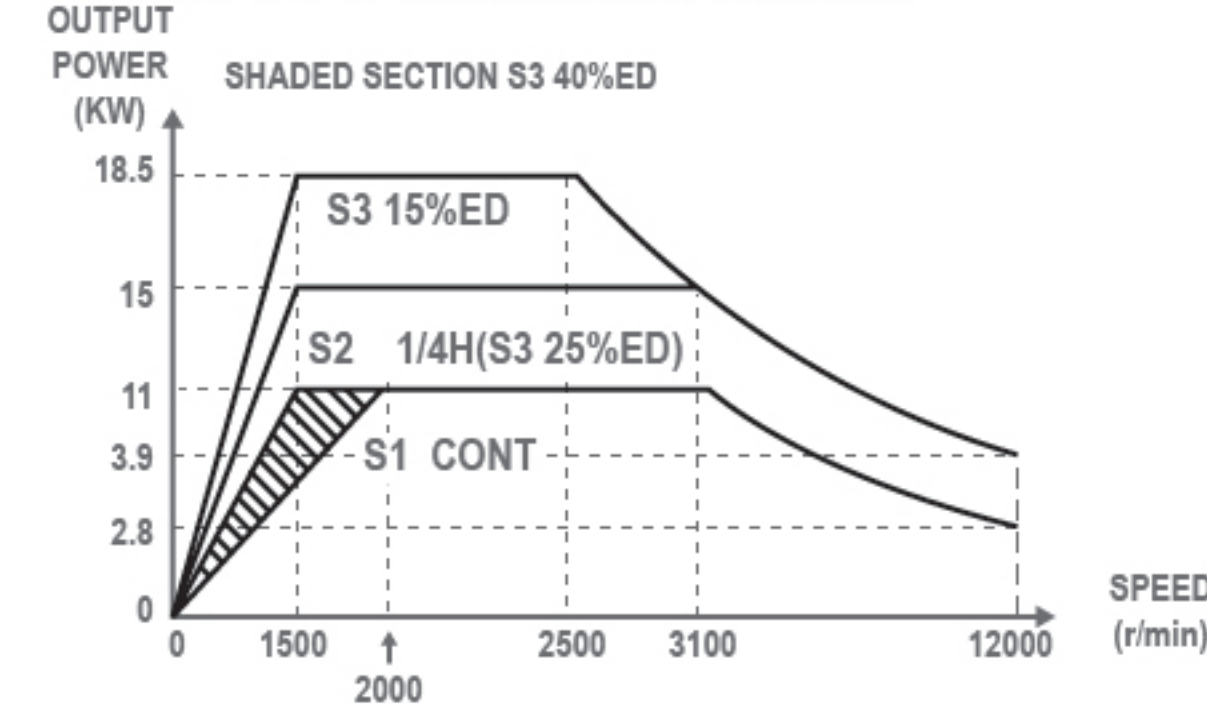

OUTPUT POWER-SPEED CHARACTERISTIC NORMAL

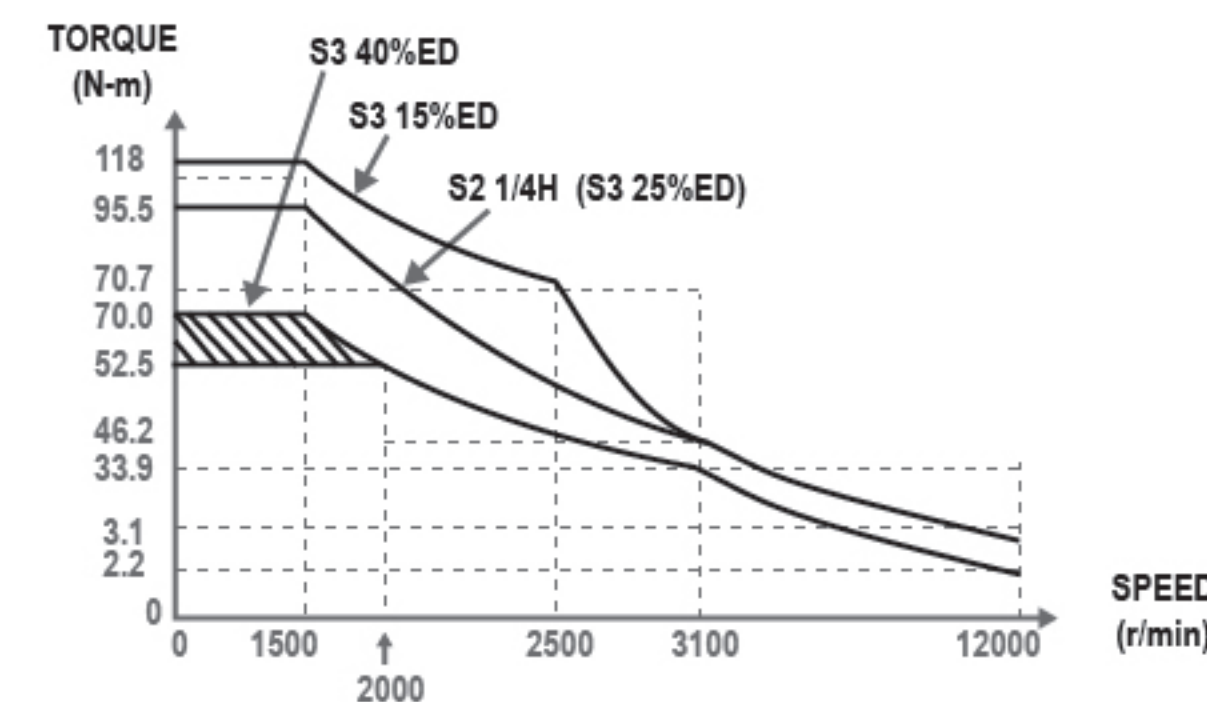

TORQUE-SPEED CHARACTERISTIC NORMAL

Spindle BBT40 12000rpm
LOW SPEED/15KW/106NM(1/2H)
HIGH SPEED/15KW/40.3NM(1/2H)
 SJ-DG15/120-02T-K

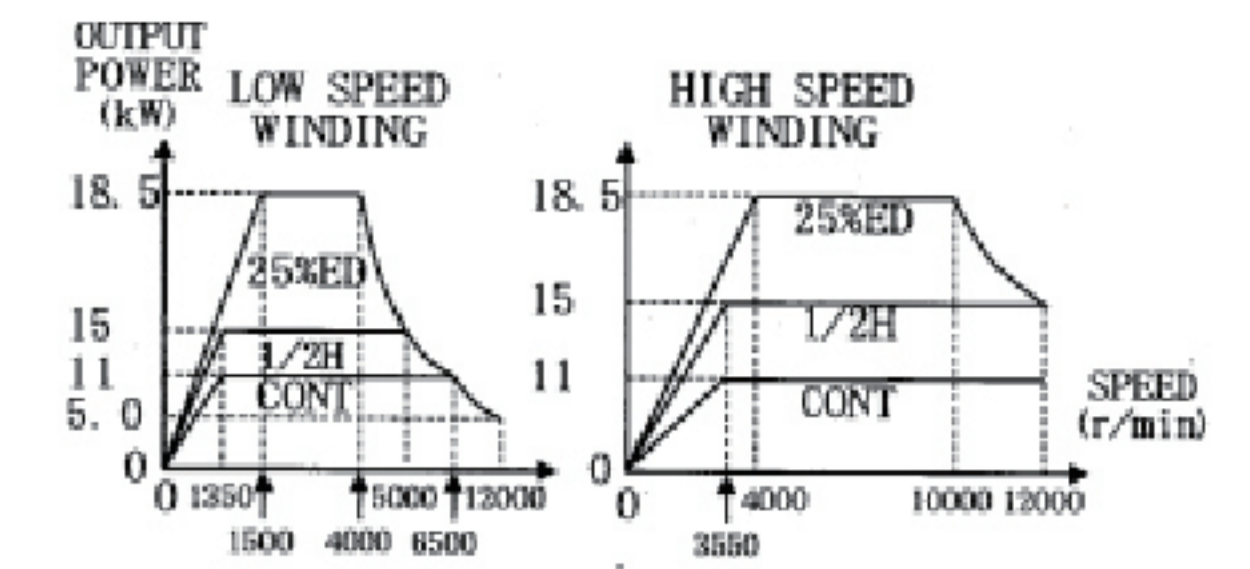

OUTPUT POWER - SPEED CHARACTERISTIC NORMAL

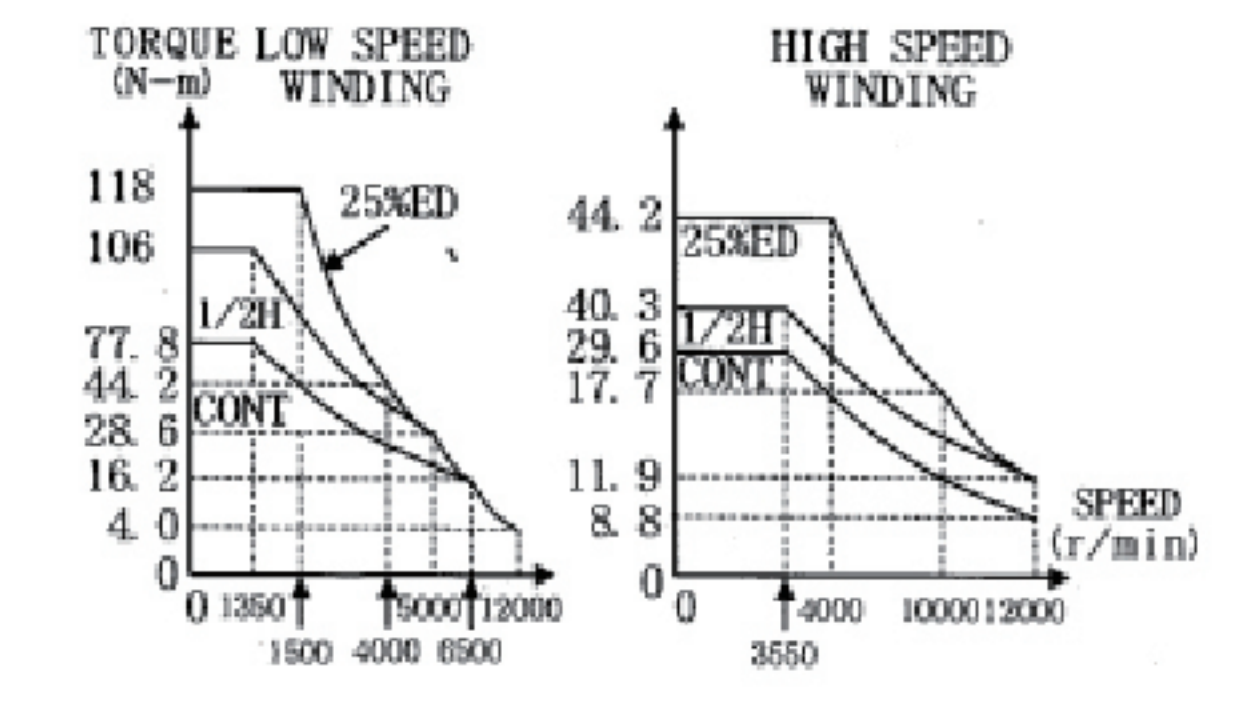

TORQUE - SPEED CHARACTERISTIC NORMAL

Chip removal capacity



Limit face milling
 Material: P20
 Tool: D50/3 flute mills
 Feed: 2400mm/min
 Rotation speed: 1000rpm



Chip removal rate 230.4cm³/min

AE 40mm

Max AP 2.6mm

Material: 6061 aluminum
 Minimum M1
 Maximum M26 (Load 86%)

Standard Accessories

- FANUC 0i-MF Plus(10.4 ") controller
- Or Mitsubishi M80(10.4")controller



Program transfer Tool setter Accuracy adjustment Home page Auto edge searching

Optional Accessories

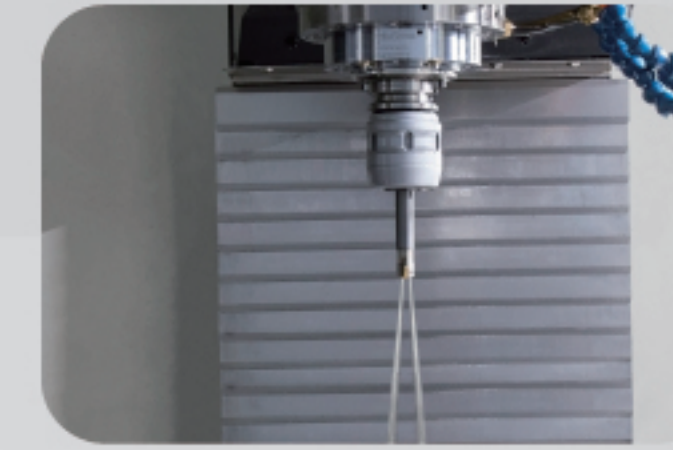

Coolant through spindle

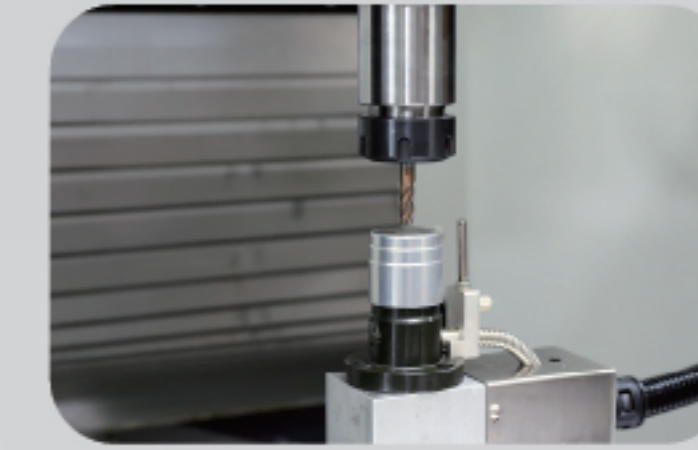

Tool setter

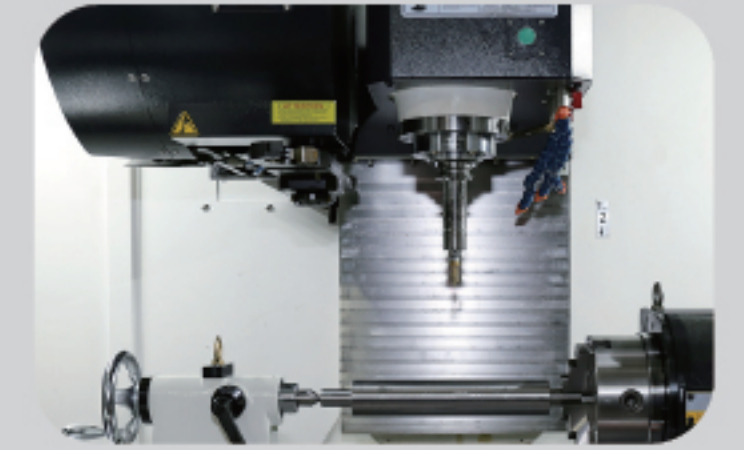

4th axis rotary table



5th axis rotary table



- ATC + Full enclosed ATC cover
- Ring spray coolant+ LED light

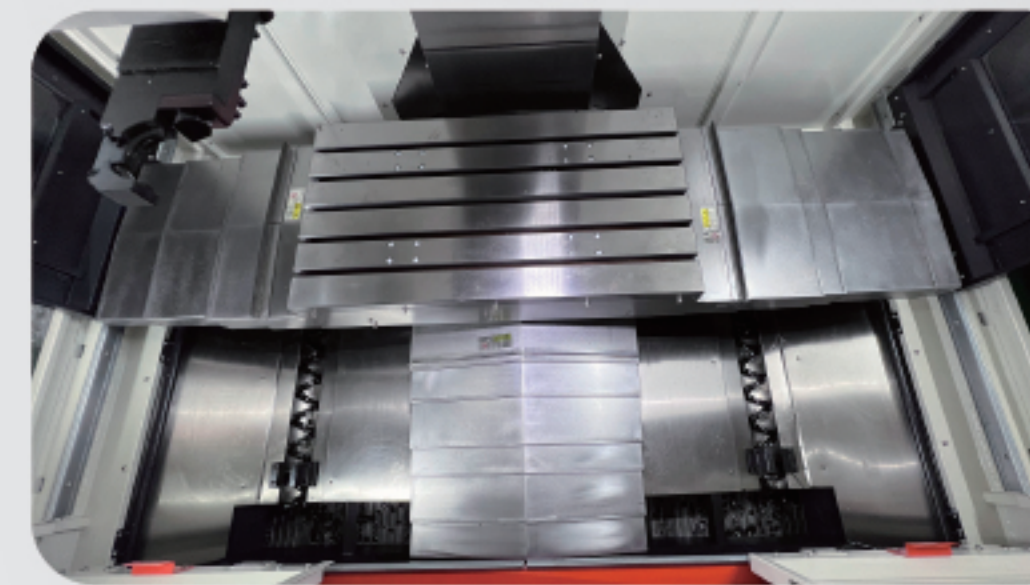

- Y direction double screw chip conveyor



- Spindle oil coolant



- Chip conveyor



Item	Unit	BF-V13
Travel	X axis travel	mm 1300
	Y axis travel	mm 750
	Z axis travel	mm 700
Distance	Spindle center to column	mm 770
	Spindle nose to table surface	mm 130-830
Worktable	Worktable area	mm 1450x700
	Dimension of T-slot	mm 5-18x152
	Max.worktable load	kg 1000
Spindle	Spindle taper	BBT40
	Spindle motor/ (S2-15min S3/S6-25%) (Fanuc)	kw/NM 15/95.5
	Spindle motor/torque (S2-15min S3-25%) (Mitsubishi)	kw/NM 15/95.5
	Max.spindle speed	rpm 12000
	Rapid feed rate-X/Y/Z (Fanuc)	m/min 36/30
Axial	Rapid feed rate-X/Y/Z (Mitsubishi)	m/min 36/30
	Axis acceleration	g 1.0
	Axis feed motor-X/Y/Z (Fanuc)	kw 3.0/3.0/3.0
	Axis feed motor-X/Y/Z (Mitsubishi)	kw 3.0/3.0/3.0
	X axis screw (Dia./pitch)	mm 4512/4510
	Y axis screw (Dia./pitch)	mm 4512/4510
	Z axis screw (Dia./pitch)	mm 4512/4510
	Linear guide width(X/Y/Z)	mm 45/45/45
	Max.tool length	mm 300
Tools	Max.tool weight	kg 7
	Tool magazine capacity	24/30
	Max.tool(full)	mm 80
	Max.tool diameter(without adjacent tools)	mm 150
	Tool change time	sec. 1.75
	Pull stud angle	deg. BT40/45°
	Tool selection method	Proximity tool selection
Accuracy (ISO230-2)	Positioning accuracy(bi-direction)	mm ±0.003/300
	Repeat positioning	mm ±0.002/300
	Power requirement	KVA 25
Machine	Min/Max.air pressure	kg/cm ² 5-7
	Coolant tank capacity	L. 510
	Std.NC controller(Fanuc)	MITSUBISHI M80
	Std.NC controller (Mitsubishi)	Fanuc Oi-MF PLUS
	Floor space requirement	mm 4220x3300
	Machine height	mm 3390
	Machine weight	kg 8000

Standard Accessories:

- FANUC Oi-MF (10.4 ") control Or Mitsubishi M80 (10.4") control"
- Fully enclosed metal cover
- 24T tool magazine
- Spindle oil cooler
- Ring spray
- LED working light
- Machine head LED light
- Heat exchanger
- Chassis flushing system
- Auto central lubrication system
- Alarming light
- Auto power off
- Safe door lock
- Rigid tapping
- MPG
- Basic installation sets
- Leveling pads
- Air gun
- High pressure water gun

Optional Accessories

- FANUC Oi-MF (15 ") controller Or MITSUBISHI M80 (15 ") controller"
- 30T tool magazine
- Air conditioner for electric cabinet
- Auto door
- Oil mist collector
- 20KG/30KG CTS
- Dual screw chip conveyor (front drawer type)
- Dual screw + chain type chip conveyor (left out)
- BT40 side milling toolholder
- Tool setter (for tool length)
- Tool setter (for tool length & radius)
- Laser tool setter
- Auto part measuring
- 4th axis rotary table (Max.φ320)
- 5th axis rotary table (Max.φ320)

	Machining center	
	M80 series	
	TypeA	TypeB
Max Number of Axes (NC Axes+Spindles+PLC axes)	11	9
"Max. Number of NC Axes(In Total of All the Part Systems)"	8	5
Max. Number of Spindles	2	2
Max. Number of PLC Axes	6	6
Number of Simultaneous Contouring Control Axes	4	4
Max. Number of NC Axes in a Part System	8	5
Max. Number of Part Systems	2	1
Control Unit-side High-speed Program Server Mode	—	—
Display Unit-side High-speed Program Server Mode	○	○
Front-side SD Card Mode	○	○
Least Command Increment	0.1μm	0.1μm
Least Control Increment	1nm	1nm
Max. Number of Tool Offset Sets	400 sets	400 sets
Max. PLC Program Capacity[Steps]	64000	32000
Multiple-project PLC (Max. Number of Projects)	3	1
Touch Gesture Operation	○	○
Level Management Operation Authority Function	○	○
Workpiece Coordinate System Offset	—	—
3D Program Check	○	○
Interactive Cycle Insertion	—	—
Multiple-spindle Synchronization	—	—
Spindle Superimposition Control	—	—
High-accuracy Control	○	○
High-speed High-accuracy Control I	○	○
High-speed High-accuracy Control II	○	—
SSS Control	○	—
Tolerance Control	○	—
Variable-acceleration Pre-interpolation Acceleration/Deceleration	—	—
OMR-FF Control	○	○
Rapid Traverse Block Overlap	○	○
Spindle-mode Servo Motor Control	○	○
Real-time Tuning 1(Speed Gain Switch)	○	—
Real-time Tuning 1 (Rapid Traverse Time Constant Switch)	○	—
Tool Center Point Control	—	—
Inclined Surface Machining Command	○	—
3-dimensional Manual Feed	○	—
R-Navi	○	—
CC-Link (Master/Local)	□	□
PPROFIBUS-DP (Master)	□	□
Ethernet/IP (Scan)	□	□
MES Interface Function	○	○
EcoMonitorLight Connection	□	□
Machine Group-based Alarm Stop	○	—
Smart Safety Observation	—	—

Tool Specification

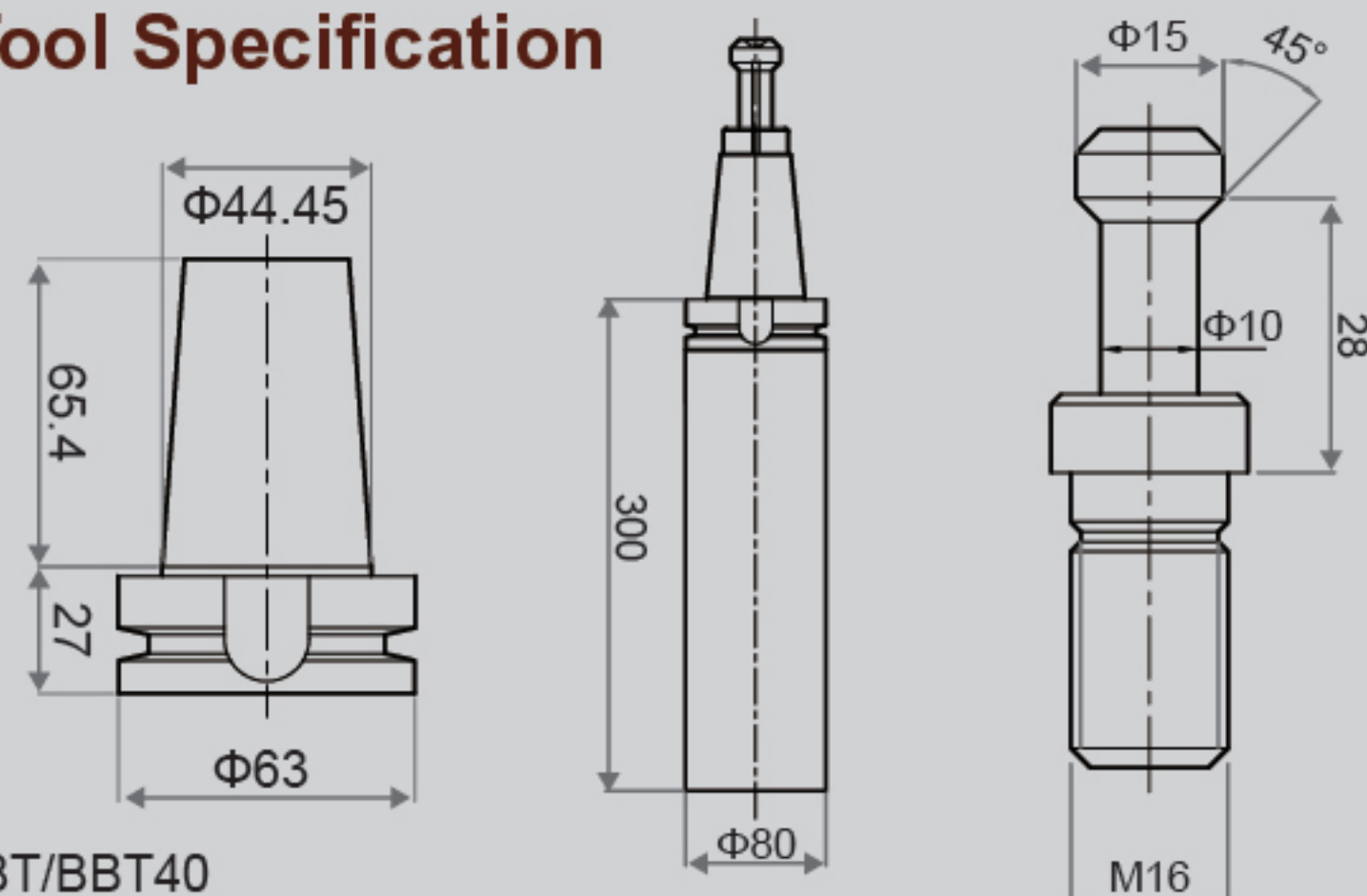

BT/BBT40
Max.tool weight:7.0KG
Max.tool Dia.:80mm Max.tool length:300mm

Machine Sheet Metal Option



Controlled axis / Accuracy compensation function		Type				
		Type 0	Type 1	Type 2	Type 3	Type 5
Control axes	3 axes(X,Y,Z)4 axes (X,Y,Z,B)	○5☆7	○5☆7	○5	○5	○5
Simultaneous controlled axes	3 axes (Max. 4 axes)	○	○	○	○	○
Least setting unit	X,Y,Z axes: 0.001mm(0.0001inch)	○	○	○	○	○
	B axis: 1deg[0.001]deg	○	○	○	○	○
Interpolation straightness compensation			☆		☆	☆
AI Thermal displacement compensation			☆		☆	☆
Ball screw thermal expansion compensation						
Inch/Metric Conversion			○	○	○	○
Linear scale optional closed loop	Add linear scale interface communication module(☆)	○	○	○	○	○
Double positions feedback	Optional when with linear scale(☆)	☆	☆	☆	☆	☆
Operation						
3D rigid tapping retraction			☆		-	-
3D manual feed			☆		-	-
3D coordinate exchange			☆		☆	-
Inclined surface indexing command			☆		☆	-
Handwheel retraction			○		○	○
Multiple steps skip			○		○	○
Processing preparation support function	Edge search		○		○	○
Small diameter deep-hole drilling cycle			○		○	☆
Dynamic graphics display			○		○	○
Program restart			○		○	○
Selected program block skip			○		○	☆
Memory card program editing and running	63 PCS		○		○	○
USB memory program running	USD DNC machining		-		-	-
iHMI		○	-	○	-	-
MANUAL GUIDE 0i		-	☆	-	☆	☆
MANUAL GUIDE i		○	☆	○	☆	-
Power-off retraction			○	○	○	○
Handwheel interruption			○	○	○	○
Interpolation function						
Nano interpolation		○	○	○	○	○
Skip	G31		○	○	○	○
One-way positioning	G60		○	○	○	○
Normal direction control	Application 1: friction welding	○	○		☆	☆
Tool front point control (TCP)	multi-axis machining	☆	☆		-	-
Mold package option						
High-accuracy program command	Include least setting Increment A~E		○	○	○	○
Pre-read program block			○		○	○
AICC I	40 block AICC I		-		-	○
AICC II	200 block AICC II		○	○	-	○
	400 block AICC II	☆	☆	○	○	-
Jerk control			○	○	○	○
Smooth tolerance control			○	○	○	○
Machining condition/mode selection			○	○	○	○
Smart adaptive Control			☆	☆	☆	☆
Program input						
Optional block skip	9 blocks		○	○	○	☆
Auxiliary/spindle function						
Cs contour control	Serial communication spindle position control		○	○	○	○
Spindle orientation	M19(S_ _ _)		○	○	○	○
Tool function / tool offset						
Tool life management			○	○	○	○
Tool broken detection			-	-		
Editing function						
Workpiece program storage	5,120m(2MB)		○	○	○	○
Extended part program editing	Copy, move and change of NC program		○	○	○	○
Data server function			☆	☆	☆	☆
Setting, display and diagnosis						
Multi language display	Support 24 languagesz		○	○	○	○9

Note: ○Standard ●Required ☆ Optional -Not Applicable Please refer to the specification sheet for details.

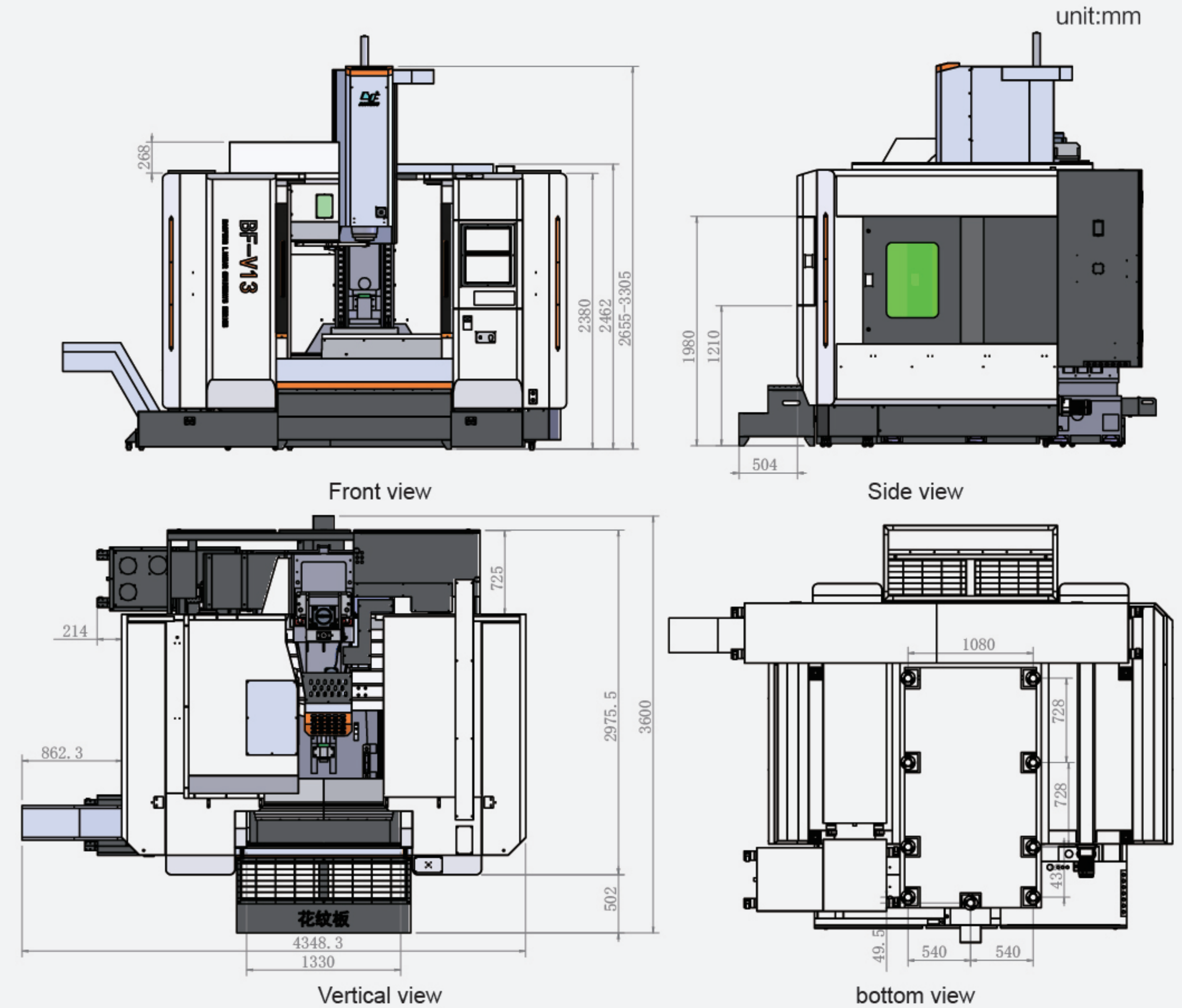

Installation preparations

NO	Project	Requirement	Remark
1	Confirm entry width and height	Enough space for equipment	External dimensions of the equipment +500mm
2	Power cable line	4*6mm ²	Sufficient to connect to the machine
3	Compressed air access	Air source filtration accuracy 100μm, air pipe outer diameter 10mm	External air pipe should be enough to connect to the machine interface
4	Shipping solution	1.Confirmation of the transport method according to the road conditions around the plant and the largest packing dimensions 1.Confirmation of equipment access according to the actual conditions	